

Common Installation Steps:

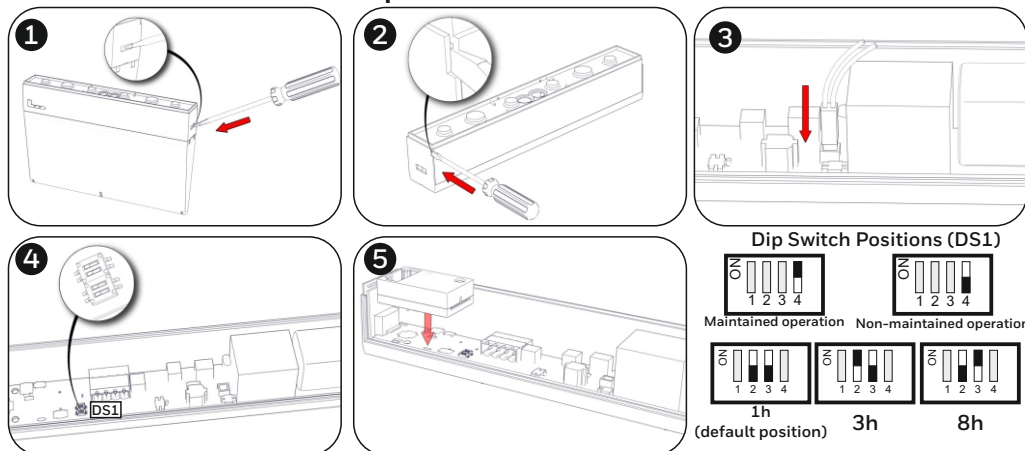

MultiLED PRO can be used as an emergency luminaire or an exit sign. See the next page for mounting methods. Below some common steps to follow.

Step 1: Place a flat blade screwdriver to remove the transparent legend from the main body by pressing gently on the retaining clips as shown in picture.

Step 2: Place a flat blade screwdriver to dismantle the the mounting part from the main body as shown in picture.

Step 3: Connect the battery cable to its respective connector on the PCB.

Step 4: The control of maintained or non maintained operation of the luminaire is achieved through Switch 4 of DS1. For maintained operation, switch number 4 must be in ON position. For non-maintained operation, switch number 4 must be in OFF position.

The user can select one of the 3 available minimum autonomy durations: 1 hour, 3 hours and 8 hours. The selection must be done while the luminaire is disconnected from AC and battery supplies. The selection is achieved through Switches 2 & 3 of DS1. Switch 1 is not used.

Two additional labels are included in the package, one for 3 hours duration (180) and one for 8 hour duration (480). Depending on the selected duration, the installer must cover the default 1 hour (60) printing with one that has the required duration.

Please take notice of the orientation of the label.

Step 5: In case you use a module connect it on the PCB.

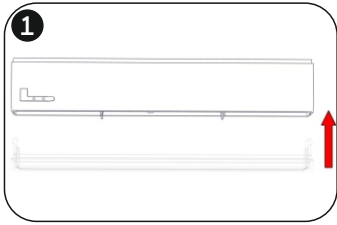

Step 1: To use MultiLED PRO as an emergency luminaire, install the provided lens.

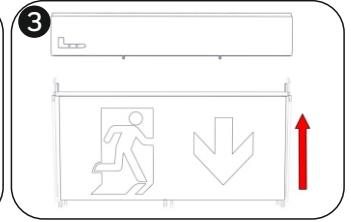
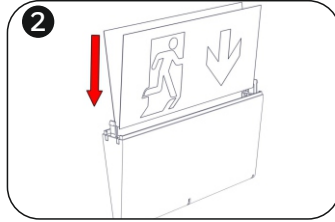
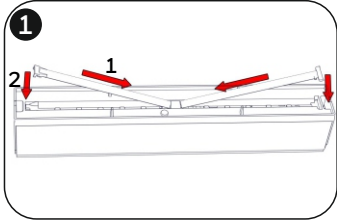

- Step 1:** To use MultiLED PRO as an exit sign, install the provided two lens, mind the correct orientation, as show in picture 2.
- Step 2:** For double sided pictogram, install the appropriate pictograms to both sides. For single sided pictogram, there is one blind pictogram in the package.
- Step 3:** Install the the transparent legend with the pictograms to the luminaire's base.

Mounting Methods

Ceiling Mounting

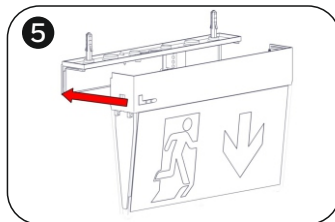
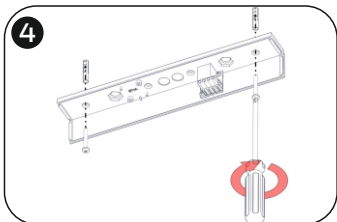
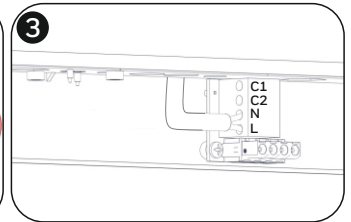
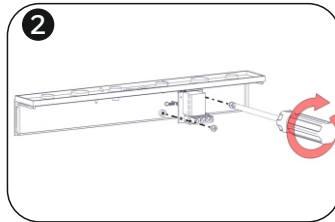
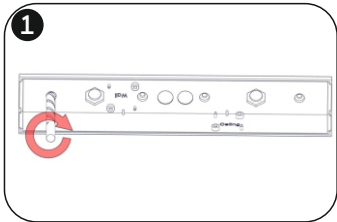

- Step 1:** Drill 2 holes, with a 3mm drill bit to the luminaire's mounting part.
- Step 2:** Install the terminal board and fasten it with the two included screws (use 3*4 screws, small one).
- Step 3:** Drill a hole on a black grommet and pass the mains cables through it. Connect the mains cables to terminal blocks: L for live wire, N for neutral and PE for ground. Power supply cables cross section should be 0.8 - 3 mm². The C1 and C2 terminals are used for eIBus communication optional), DALI communication (optional), or voltage free contact (optional). Tighten the cable tie around the cables.
- Step 4:** Fasten the mounting part with the supplied mounting accessories (with or without spacers).
- Step 5:** Slide the main body of the luminaire back to the mounting part.

Hanging Mounting

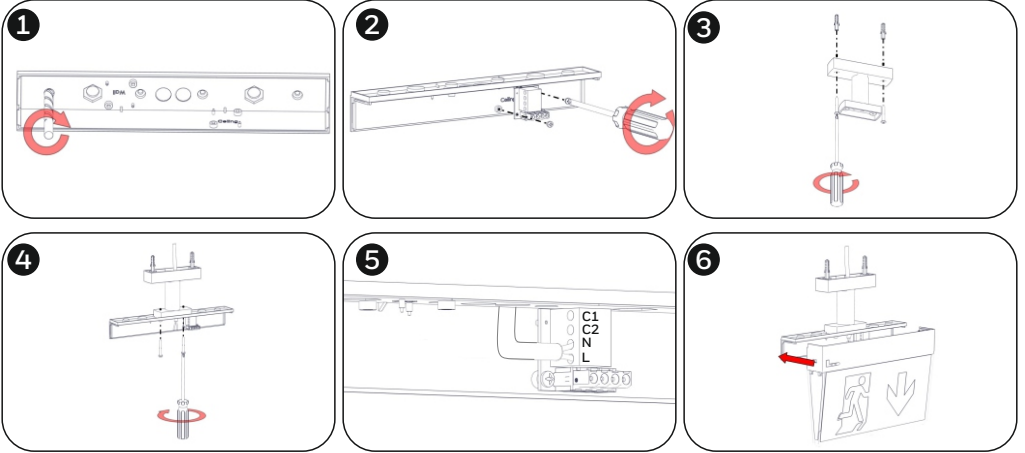

Step 1: Drill 2 holes, with a 3mm drill bit to the luminaire's mounting part.

Step 2: Install the terminal board and fasten it with the two included screws (use 3*4 screws, small one).

Step 3: Pass the cables through the hanging accessory and install it on the ceiling with the included mounting parts.

Step 4: Screw the luminaire mounting part with the two included mounting screws and pass through the power cable.

Step 5: Connect the mains cables to terminal blocks: L for live wire, N for neutral and PE for ground. Power supply cables cross section should be 0.8 - 3 mm². The C1 and C2 terminals are used for eIBus communication (optional), DALI communication (optional), or voltage free contact (optional). Tighten the cable tie around the cables.

Step 6: Slide the main body of the luminaire back to the mounting part.

Wall Mounting

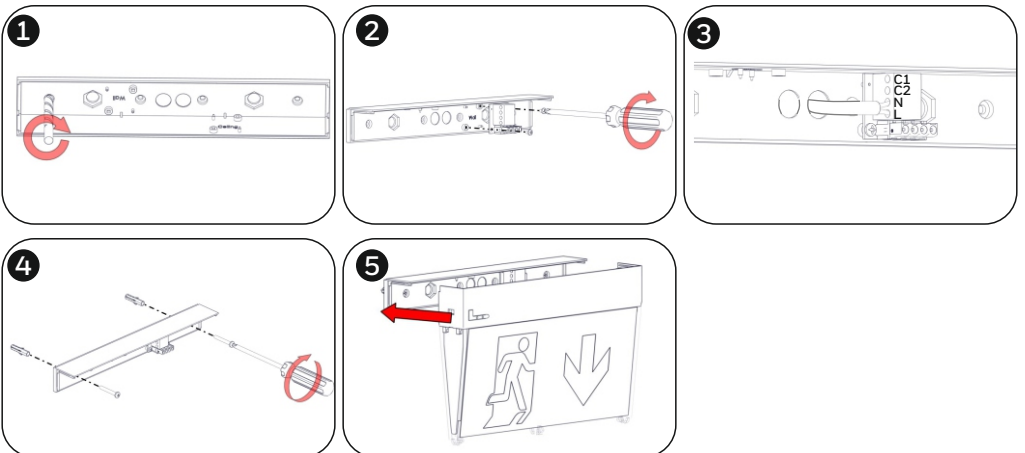

Step 1: Drill 2 holes, with a 3mm drill bit to the luminaire's mounting part.

Step 2: Install the terminal board and fasten it with the two included screws (use 3*4 screws, small one).

Step 3: Drill a hole on a black grommet and pass the mains cables through it. Connect the mains cables to terminal blocks: L for live wire, N for neutral and PE for ground. Power supply cables cross section should be 0.8 - 3 mm². The C1 and C2 terminals are used for eIBus communication (optional), DALI communication (optional), or voltage free contact (optional). Tighten the cable tie around the cables.

Step 4: Fasten the mounting part with the supplied mounting accessories.

Step 5: Slide the main body of the luminaire back to the mounting part.

Technical description	MultiLED PRO Combi ST LED 230V wpict 138h
Part no.:	138010
Operation Voltage:	220-240V AC, 50-60 Hz
Maximum Power Consumption:	5.1W / 5.3VA
Battery (NiMH):	4.8V / 1.7Ah
Battery Protection:	Overcharge protection / Deep discharge protection
Min./Max. Charge Current:	50 / 160mA
Charge Voltage Range:	4-6V
Charging Time:	16 hours
Emergency Mode Duration:	1h / 3h / 8h manually selected (default 1h)
Lumen output, normal:	300lm
Lumen output, emergency (1h/3h/8h):	350 / 240 / 100lm
Produced in accordance with:	EN 60598-1, EN 60598-2-22, EN 55015 EN 61547, EN 61000-3-2, EN 61000-3-3
Ambient Temperature Range:	5 to 40 °C
Relative Humidity:	Up to 95%
Degree of cover protection:	IP40
Technical lifetime (light source):	> 100000 hours
Weight:	500 gr
Expected Battery Lifetime:	4 years
Controlgear classification in accordance with IEC 62034:	with automatic test function

In case that the luminaire no longer meets its rated duration of operation, the battery must be replaced.

Battery Replacement:

Disconnect mains, carefully remove the luminaire from the ceiling or wall. Dismantle the luminaire. Disconnect the battery and install a new one of the same type and characteristics.

Note: In case of battery replacement, this must be replaced with parts of the same type and characteristics. The replacement must be performed by the manufacturer of a competent person.

Note: If the supply cable of the luminaire is damaged, it shall exclusively be replaced by a competent person in order to avoid hazard.

Note: In case of mains power disconnection for a period of more than two months, the battery must be disconnected.

Important notice when installing luminaires within the same area!!!

















To avoid that luminaires perform their battery test at the same day, connect the battery packs with more than 1,5 minutes inbetween.

 The light source contained in this luminaire shall only be replaced by the manufacturer, or his agent, or a similar qualified person.

NOTE! The light source is non-user replaceable.

 At the end of their useful life the packaging, product and batteries should be disposed of via a suitable recycling centre. Do not dispose of with your normal household waste. Do not burn.





Indicator LEDs	Description
<div style="display: flex; justify-content: space-around;"> <div style="text-align: center;"> <p>GREEN</p>  </div> <div style="text-align: center;"> <p>RED</p>  </div> </div>	Normal
<div style="display: flex; justify-content: space-around;"> <div style="text-align: center;">  </div> <div style="text-align: center;">  </div> </div>	Charging (battery test not possible while charging)
<div style="display: flex; justify-content: space-around;"> <div style="text-align: center;">  </div> <div style="text-align: center;">  </div> </div>	Mains off, battery not connected or charger fault
<div style="display: flex; justify-content: space-around;"> <div style="text-align: center;">  </div> <div style="text-align: center;">  </div> </div>	Battery test (Duration: 1h,3h,8h)
<div style="display: flex; justify-content: space-around;"> <div style="text-align: center;">  </div> <div style="text-align: center;">  </div> </div>	Battery fault
<div style="display: flex; justify-content: space-around;"> <div style="text-align: center;">  </div> <div style="text-align: center;">  </div> </div>	Light source test (Duration: 3s)
<div style="display: flex; justify-content: space-around;"> <div style="text-align: center;">  </div> <div style="text-align: center;">  </div> </div>	Light source fault
<div style="display: flex; justify-content: space-around;"> <div style="text-align: center;">  </div> <div style="text-align: center;">  </div> </div>	Battery fault and light source fault

LED Status explanation

 Off

 On

 Slow Blink

 Fast Blink

The MultiLED PRO is a self-contained maintained/non-maintained luminaire with selftest function.

Selftest functions

Every 15 days the luminaire will perform an emergency operation test. This will turn on the light source for approximately 3 seconds. The green LED will flash during this test sequence.

Every 6 months the luminaire will perform a battery condition test. The test will last for the chosen autonomy. The light source will be lit and the green LED will flash during this test sequence.

Note: When using DALI or Wireless communication, the frequencies and schedules for tests will instead be determined by the connected PC software.

Manual test functions

Manual tests can only be performed if both mains and battery are connected.

By pressing the test button briefly (less than 5 seconds) an emergency operation test is performed. The light source will be lit for approximately 3 seconds, the green LED will flash during this test sequence.

By pressing the test button for between 5 and 10 seconds a battery condition test is performed. This test will last for the chosen autonomy and can only be performed when the battery is fully charged (steady green LED). The light source will be lit and the green LED will flash during this test sequence.

Resetting errors

Push the test button for >10 seconds to delete all indicated errors. Then the luminaire enters regular operation mode.

Dimming

By pressing the test button continuously > 15 seconds, when luminaire is connected to mains, the luminosity will be reduced to 10% of its total luminance. In emergency mode the light output will remain unchanged.

To restore the original settings, repeat the above procedure.

The dimming setting remains stored in the luminaire even when both mains and battery voltages are disconnected.